

|    |    |      |     |    |
|----|----|------|-----|----|
| 5  | 6  |      |     |    |
| 标记 | 处数 | 变更内容 | 编制人 | 日期 |
|    |    |      |     |    |
|    |    |      |     |    |

# 德尔玛说明书印刷要求

## 颜色规范:

 黑色印刷  
C0 M0 Y0 K100

 专色印刷  
PANTONE123 C  
C0 M20 Y100 K0

 内容印刷  
C0 M0 Y0 K70

 内容印刷  
C0 M0 Y0 K15

 LOGO-灰色及部分内容印刷  
C0 M0 Y0 K50

**材质+工艺:**  
**1专+4色印刷**  
材质双胶纸80克, 折页

**尺寸:**  
成品尺寸: 90×210mm,  
展开尺寸: 630×210mm

| 未注公差带<br>GB/T 1804-2000 |       |      |      |      |
|-------------------------|-------|------|------|------|
| 基本尺寸                    | 精密f   | 中等m  | 粗糙c  | 最粗v  |
| 0.5~3                   | ±0.05 | ±0.1 | ±0.2 | -    |
| >3~6                    | ±0.05 | ±0.1 | ±0.3 | ±0.5 |
| >6~30                   | ±0.1  | ±0.2 | ±0.5 | ±1   |
| >30~120                 | ±0.15 | ±0.3 | ±0.8 | ±1.5 |
| >120~400                | ±0.2  | ±0.5 | ±1.2 | ±2.5 |
| >400~1000               | ±0.3  | ±0.8 | ±2   | ±4   |
| >1000~2000              | ±0.5  | ±1.2 | ±3   | ±6   |
| >2000~4000              | -     | ±2   | ±4   | ±8   |



**德尔玛**

|   |             |
|---|-------------|
| 视角  | 页数          |
|  | 第 1 页 共 1 页 |

|      |                   |      |    |
|------|-------------------|------|----|
| 版本   | A0                |      |    |
| 产品型号 | VX100             |      |    |
| 物料名称 | 说明书               |      |    |
| 图号   | VX100-M3170-00012 |      |    |
| 材质   | 见技术要求             |      |    |
| 图框   | 净重                | 比例   | 单位 |
| A4   | 0g                | 1: 1 | mm |

Operation

Adding the clean water

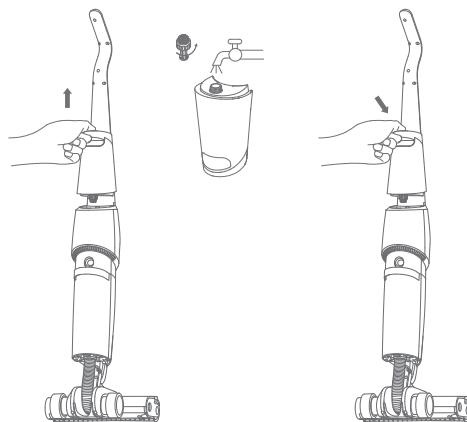

1. Press and hold the clean water tank release button to remove the clean water tank.
2. Remove the clean water tank cap by rotating it counterclockwise, fill it with clean water and then close it tightly.
3. Re-install the clean water tank until you hear a click.

Starting cleaning

Press the power button briefly to start cleaning. Press the button again to stop cleaning. Press the mode switching button to switch between the auto mode, suction mode and eco mode.

Note:

- If the appliance is turned off while lying down, please stand the appliance upright. This prevents internal sewage from backing up onto the floor.
- To get a better cleaning performance, it is recommended to wait for the appliance to dampen the roller brush before cleaning the floor after turning on the appliance.

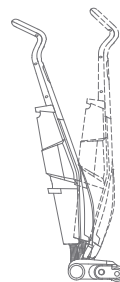

Self-cleaning

1. Place the appliance back to the charging base, and press the self-cleaning button briefly to start the self-cleaning.
2. Press the self-cleaning button briefly to pause/restart the self-cleaning.
3. Empty the dirty water tank while self-cleaning is completed.

Operation

Drying the brush\*

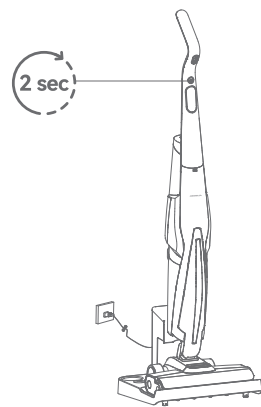

- The appliance starts drying mode automatically after self-cleaning is completed.
  - Press and hold the self-cleaning button for 2 seconds to start the quick drying mode. Press the button again to pause/restart the quick drying mode.
  - Press the power button or the mode switching button briefly to exit the drying mode.
- \* This function is only available on the VX100 Ultra.

Emptying the dirty water tank

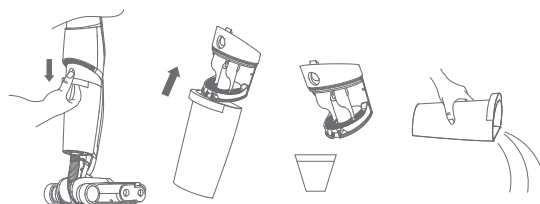

1. Press the tank release button to remove the dirty water tank as shown.
2. Remove the dirty water tank lid and dump the trash.
3. Re-install the dirty water tank lid to the dirty water tank, and install the dirty water tank back into the main body.

Turning on/off voice prompt

In power on, press and hold the self-cleaning button for 3 seconds to turn off the voice prompt, and then press and hold the button again for 3 seconds to turn on the voice prompt.

Care and Maintenance

**WARNING:** Before cleaning and maintaining the appliance, it should be turned off and the power plug should be unplugged.

Cleaning the dirty water tank and the filter assembly

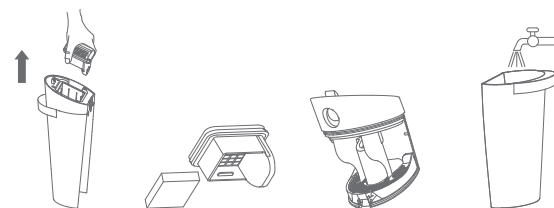

Rinse the dirty water tank, dirty water tank lid, filter basket and the filter sponge with clean water. The provided cleaning brush can be used to clean the inner wall of the tank.

Cleaning the floor brush head

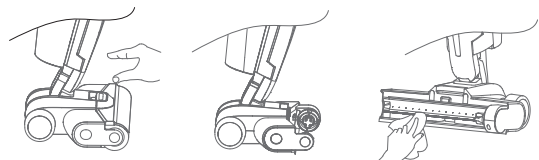

Remove the brush head cover and roller brush. Then wipe the suction inlet with a dry cloth.

Cleaning the roller brush

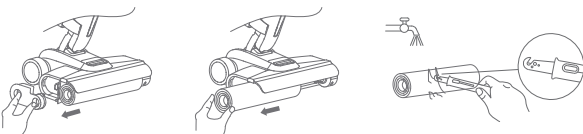

1. Press the side cover release button to remove the brush head side cover, and then remove the roller brush.
2. Clean out any hair and debris tangled on the roller brush with the provided cleaning brush. Rinse the roller brush with clean water.
3. Re-install the roller brush and the brush head side cover until you hear a click.

Troubleshooting

If an error occurs, the appliance will stop working. Please refer to the following table for troubleshooting. If the problem persists, please contact the customer service.

| Fault                                    | Cause   | Solution  |
|--|---|---|
| The appliance does not work.             | Battery exhausted.  | Fully charged for use.  |
|  | Battery overheat protection.  | Wait until the battery's temperature returns normal.                      |
|  | Dirty water tank, clean water tank or brush roller are not installed.       | Install the dirty water tank, clean water tank and brush roller properly. |
|  | Dirty water tank is full.   | Empty the dirty water tank.   |
|  | Clean water tank is short of water.   | Fill the clean water tank with clean water.                               |
|  | Brush head or dirty water tank pipe is blocked.                             | Clean the brush head and pipe.  |
| No water is coming out of the appliance. | Roller brush is entangled.  | Clean the roller brush.   |
|  | Handle is not installed in place.   | Re-install the handle.  |
| The bottom of brush head leaks water.    | Clean water tank is short of water.   | Fill the clean water tank with clean water.                               |
|  | Clean water tank is not installed in place.                                 | Re-install the clean water tank.  |
| Abnormal charging.                       | The filter sponge is not installed.   | Install the filter sponge.  |
|  | The filter sponge is not completely dry after being cleaned.                | Dry the filter sponge completely before use.                              |
|  | Too many water stains are on the floor.                                     | It is recommended to switch to the suction mode.                          |
| No voice prompt.                         | The charging base plug is not inserted into the electrical outlet properly. | Make sure the charging base plug is inserted in place.                    |
|  | The appliance is not placed onto the charging base properly.                | Make sure the appliance is placed onto the charging base properly.        |
| Self-cleaning does not work.             | Dirty water tank is full.   | Empty the dirty water tank.   |
|  | Dirty water tank and clean water tank are not installed.                    | Re-install the clean water tank and dirty water tank.                     |
|  | Low or depleted battery.  | Ensure the power is sufficient to use the self-cleaning function.         |

Specification

VX100

Main unit

Product name: Water-absorbing vacuum cleaner (Cordless wet & dry vacuum)  
 Product model: VXPDI1L  
 Working voltage: 21.6 V  $\equiv$   
 Working power: 300 W

Charging base

Product model: VXCB1C  
 Rated input: 220-240 V~ 50-60 Hz  
 Rated output: 26 V  $\equiv$  1 A  
 Rated power: 27 W

VX100 Ultra

Main unit

Product name: Water-absorbing vacuum cleaner (Cordless wet & dry vacuum)  
 Product model: VXPDI2L  
 Working voltage: 21.6 V  $\equiv$   
 Working power: 300 W

Charging base

Product model: VXCB1D  
 Rated input: 220-240 V~ 50-60 Hz  
 Rated output: 26 V  $\equiv$  1 A  
 Rated power: 150 W

# User Manual

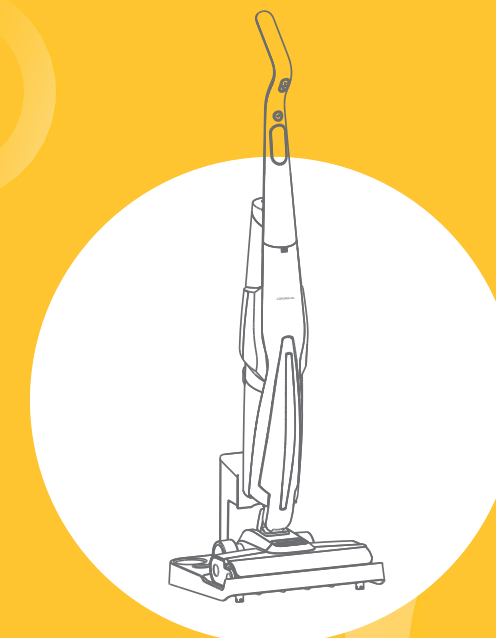

## VX100 Series

Deerma  
Cordless Wet&Dry Vacuum

Read instruction manual carefully before use.

## Safety Information

This appliance is intended for household use only. Please read this user manual carefully before using the appliance and keep it properly.

1. This appliance is not intended for use by persons (including children) with reduced physical, sensory or mental capabilities, or lack of experience and knowledge, unless they have been given supervision or instruction concerning use of the appliance by a person responsible for their safety.

2. Children should be supervised to ensure that they do not play with the appliance.

3. This appliance can be used by children aged from 8 years and above and persons with reduced physical, sensory or mental capabilities or lack of experience and knowledge if they have been given supervision or instruction concerning use of the appliance in a safe way and understand the hazards involved. Children shall not play with the appliance. Cleaning and user maintenance shall not be made by children without supervision.

4. Do not use outdoors, on non-floor surfaces, or in commercial or industrial environments.

5. Do not use to pick up high-temperature substances (e.g., unextinguished cigarette butts, matches, hot ashes, etc.), ultra-fine particulates (e.g., lime, cement, wood chips, gypsum powder, ashes, charcoal powder, etc.), dangerous items (e.g., solvents, detergents, etc.), corrosive chemicals, foamy liquids, and other substances with uncertain physical properties.

6. Do not use to pick up flammable and explosive liquids such as gasoline, and it is prohibited to pick up toxic solutions, such as ammonia bleach, ammonia water, or sewer cleaners.

7. Do not use to pick up sharp substances, such as glass fragments, toys, pins, paper clips, stones, gypsum, or large pieces of paper. These substances may cause blockages or damage the appliance.

8. Do not use to pick up stains with strong grease, stickiness or dyeing properties such as shoe polish, paint, or pigments.

9. Do not charge or store the product near heat sources or in damp areas (e.g., radiators, kitchen, or bathroom).

10. Do not add disinfectants, essential oils, vinegar, perfumes, etc. to the water tank, as they may damage the appliance.

11. Do not place any small objects at the air outlet or block the air outlet. Promptly remove all small objects that may hinder the smooth airflow of the air outlet to prevent the product from overheating.

12. Do not immerse the appliance in liquids or expose it to direct sunlight.

13. Use extra caution when cleaning on stairs.

14. Do not lift, carry, tilt, or lay the appliance flat while it is in operation to prevent the liquid from flowing back into the motor.

15. Do not wet the appliance, as this may cause a short circuit, leading to fire or electric shock.

16. This appliance contains batteries that are only replaceable by skilled persons.

17. Do not use any third-party batteries.

## Safety Information

18. WARNING: For the purposes of recharging the battery, only use the detachable supply unit VXCB1C (for VXP11L)/VXCB1D (for VXP12L) provided with this appliance.

19. Please charge according to the rated voltage specified on the charging base.

20. Do not touch the plug or any live parts of the appliance with wet hands to prevent the risk of electric shock.

21. It will be dangerous if the product is used on the power cord.

22. Unplug the appliance before cleaning or performing maintenance.

23. If the supply cord is damaged, it must be replaced by its service agent or similarly qualified persons in order to avoid a hazard.

24. In the event of a malfunction, such as overheating, abnormal noise, unusual odor, or weak suction, it is recommended to contact the official after-sales service. Do not disassemble, repair or modify the appliance or charging base without authorization.

25. Do not disassemble or reassemble any parts other than the detachable components specified in this user manual, otherwise, it may result in danger.

26. Use only as described in this user manual. Any losses caused by improper use shall be borne by the user.

## Battery Removal and Disposal

The chemical substances contained in the lithium-ion battery built into this product may cause pollution to the environment. Before discarding it, please have it removed by professional personnel and hand it over to professional battery recycling institutions for centralized disposal.

- Before discarding the appliance, the battery must be removed from the appliance;
- When removing the battery, the appliance must be powered off;
- The battery should be disposed of safely.

1. Use a suitable screwdriver to remove the six screws between the main body and the dirty water tank, then detach the main body cover.

2. Pull out the black silicone plug on the exterior of the main body. Next, remove the four screws on the outside of the main body and remove the main body cover.

3. Remove the four screws securing the motor assembly, then detach the motor assembly.

4. Remove the two screws under the motor assembly, the six screws under the main body cover, and the two screws under the connector with the brush head. Then, pry open the battery pack cover.

5. Remove the screws on top of the PCB board. Pull out the nickel piece connecting the main body and the PCB board (avoid touching the positive and negative terminals to prevent a short circuit). Finally, remove the bracket and separate the battery cells for disposal.



All products bearing this symbol are waste electrical and electronic equipment (WEEE as in directive 2012/19/EU) which should not be mixed with unsorted household waste. Instead, you should protect human health and the environment by handing over your waste equipment to a designated collection point for the recycling of waste electrical and electronic equipment, appointed by the government or local authorities. Correct disposal and recycling will help prevent potential negative consequences to the environment and human health. Please contact the installer or local authorities for more information about the location as well as terms and conditions of such collection points.

## Product View

Main unit

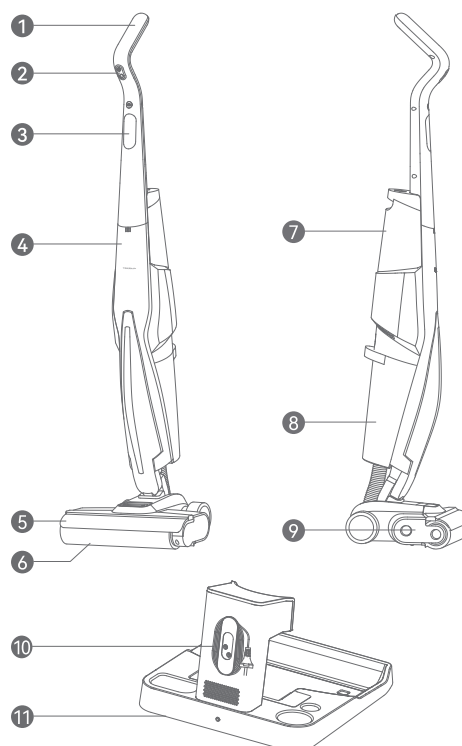

- |                    |                    |                         |
|--------------------|--------------------|-------------------------|
| 1 Handle           | 2 Control buttons  | 3 Display screen        |
| 4 Main body        | 5 Floor brush head | 6 Roller brush          |
| 7 Clean water tank | 8 Dirty water tank | 9 Brush head side cover |
| 10 Power cord      | 11 Charging base   |                         |

## Product View

Display screen

- 1 Battery level Indicator
- 2 Icon messages

Auto mode:  
Suitable for daily cleaning.

Eco mode:  
Suitable for cleaning larger areas with longer battery life.

Suction mode:  
Suitable for cleaning floors with a lot of water stains.

Self-cleaning mode:  
Self-cleaning can be enabled when the appliance is placed on the charging base for charging.

Blocked tube

Dirty water tank is full

Insufficient water in the clean water tank

Roller brush is stuck

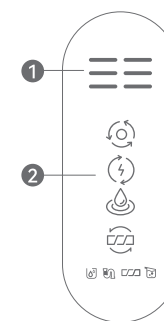

## Assembly

Installing the handle

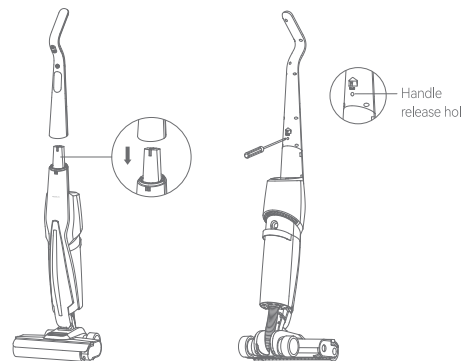

1. Handle installation:  
Insert the handle vertically into the main body until you hear a click. Ensure the handle is firmly fixed.

2. Handle removal:  
Remove the clean water tank and use the appropriate tool to insert the handle removal hole while holding the handle and pulling up.

## Assembly

Note: If the appliance does not operate normally after handle installation, please check whether the handle is installed in place.

Installing the clean water tank and dirty water tank

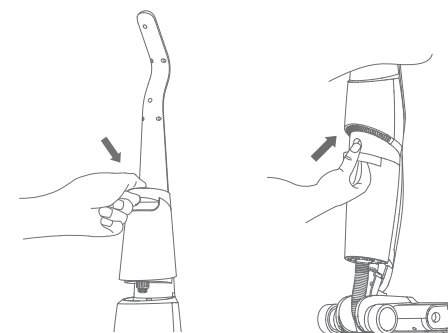

Install the clean water tank and dirty water tank into the main body in turn until you hear a click.

## Charging

Fully charge the appliance before first use. Place the charging base against a wall and connect the power supply. When all six bar indicators are lit on the display screen, the battery is fully charged.

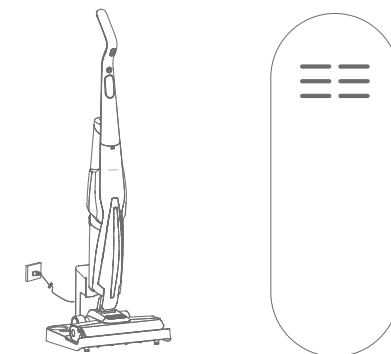

Note:

- It is recommended to fully charge for 12 hours each time for the first three charges. In daily use afterwards, it can be charged as needed.
- The self-cleaning mode can be enabled only when the battery level is more than 20% (There are more than two bars lit on the battery indicator).